

РУКОВОДСТВО ПОЛЬЗОВАТЕЛЯ
Инструкция по сборке

Металлический сарай

PANORAMA A



BLACK FOX™

garden sheds

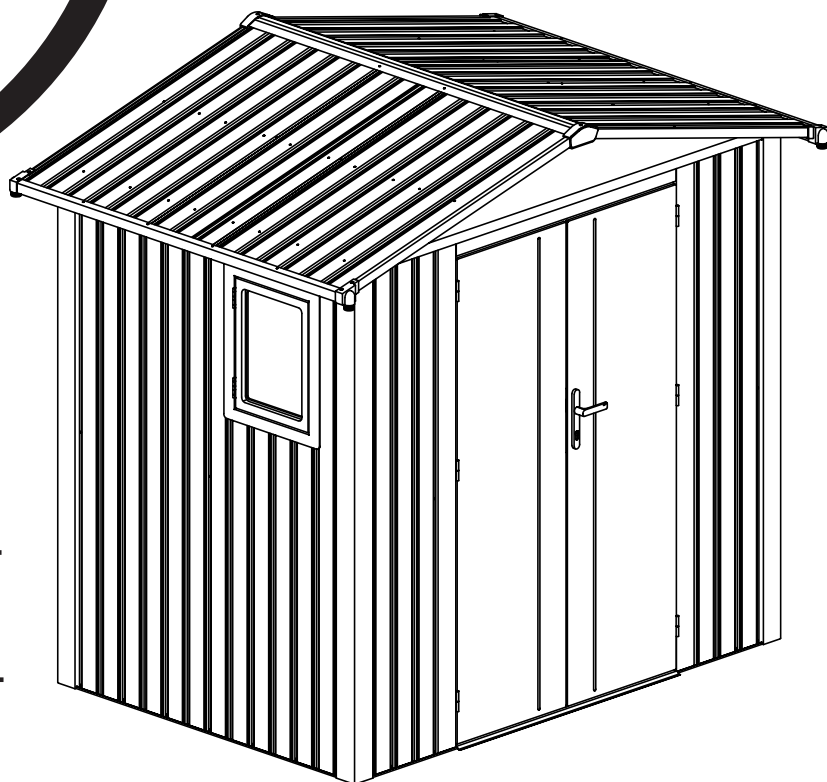

240x168x220 см

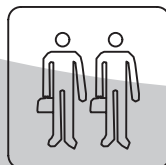
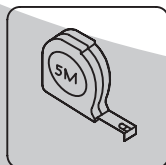
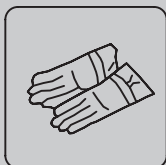
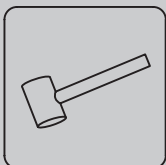
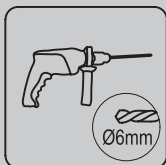
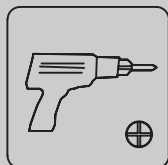

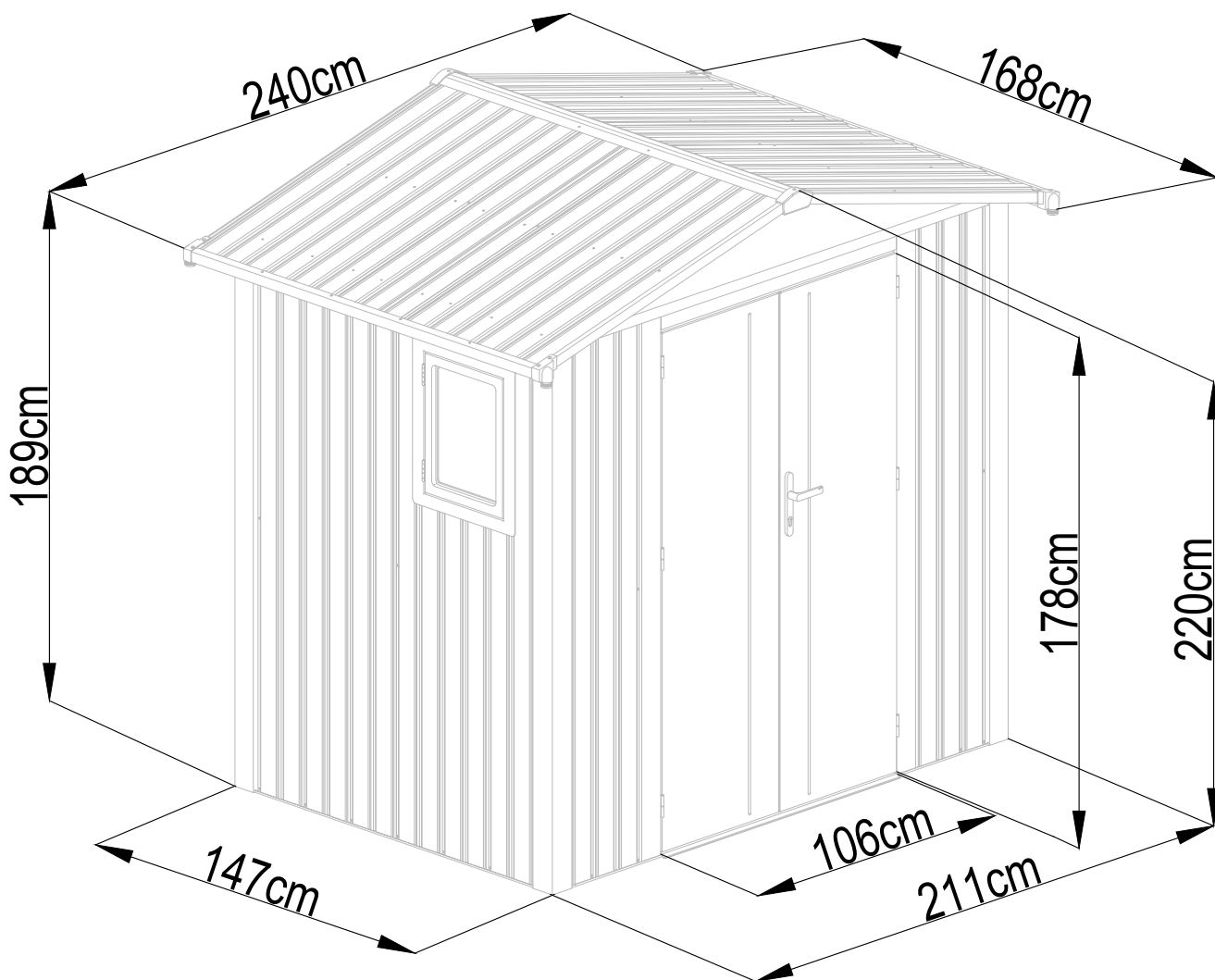



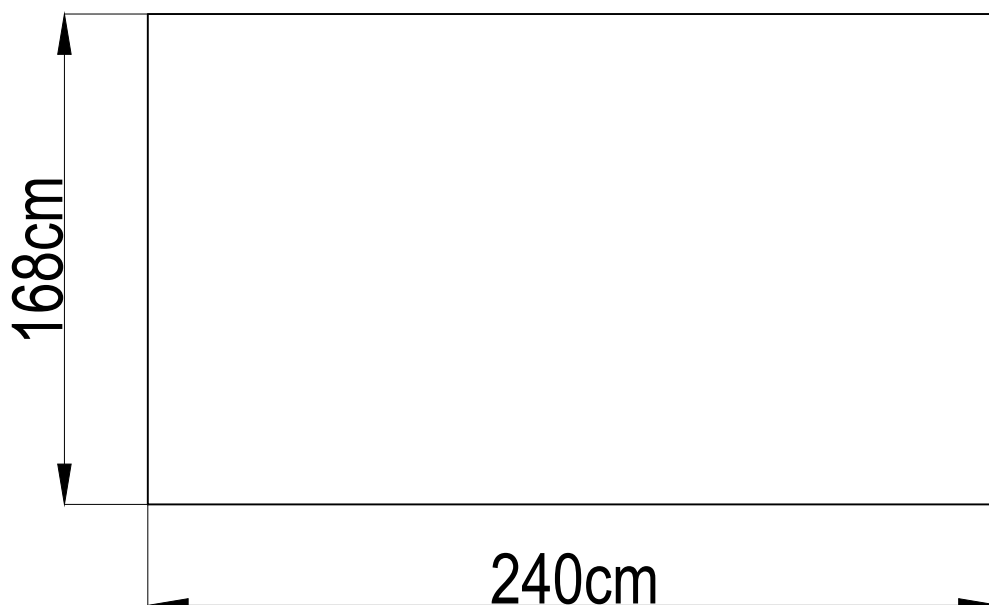

Требуемая площадь для установки:

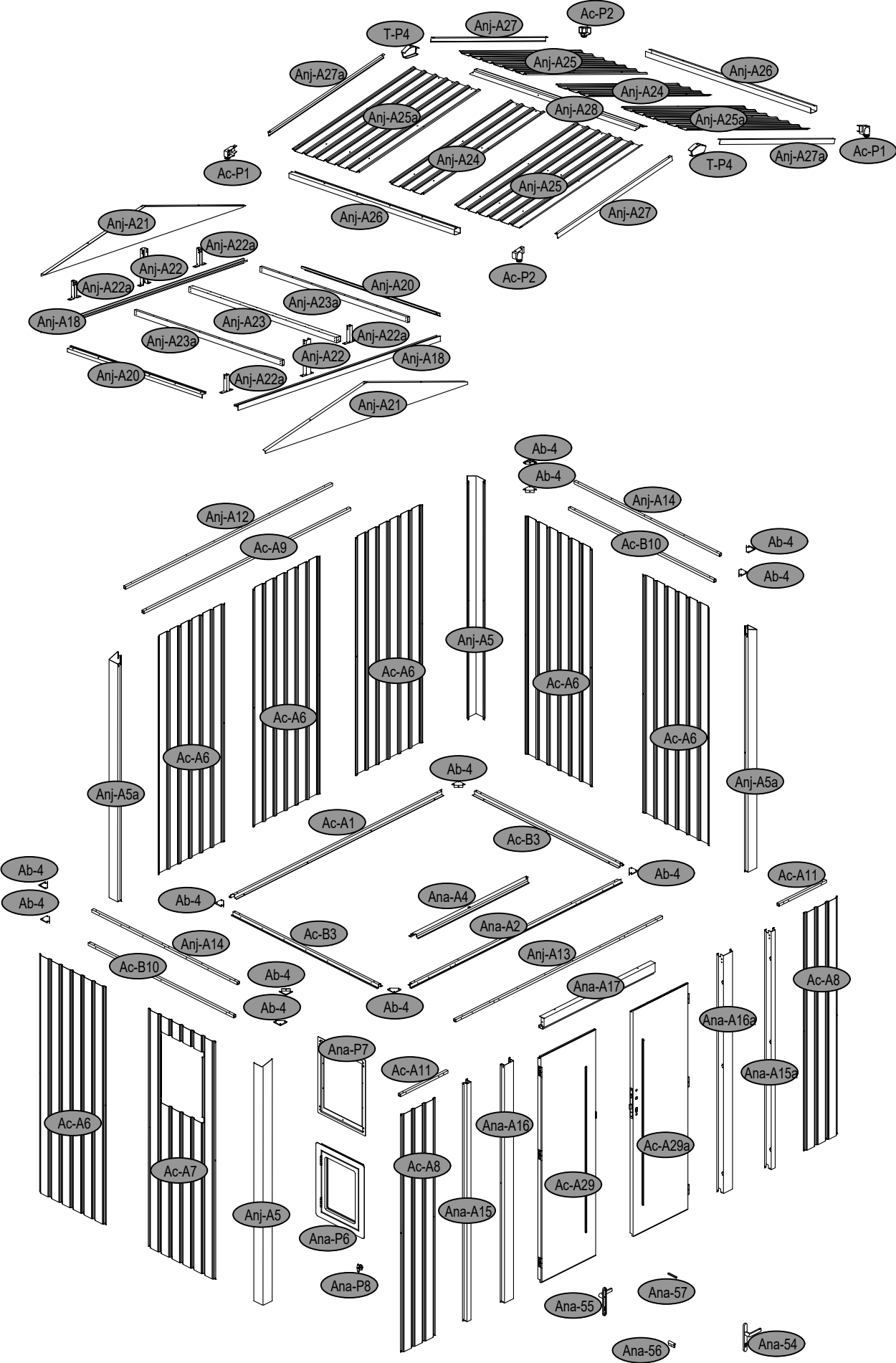

Panorama-A:



1	 Ac-A1 x1	 Ana-A2 x1	 Ac-B3 x2	
---	--	---	--	--

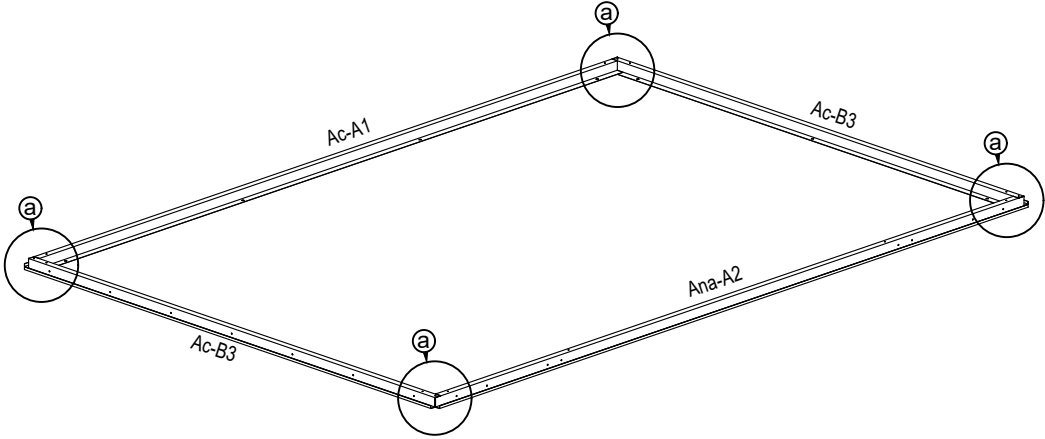
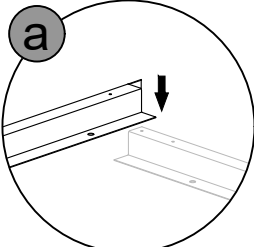



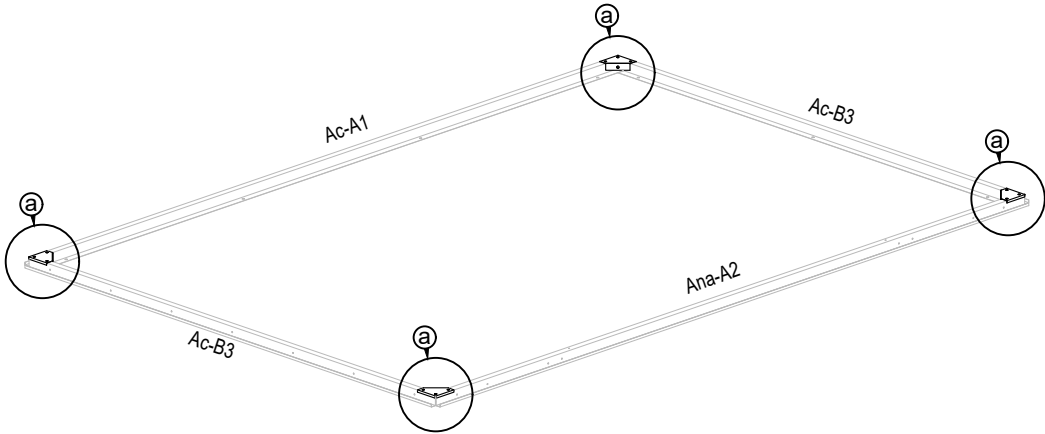
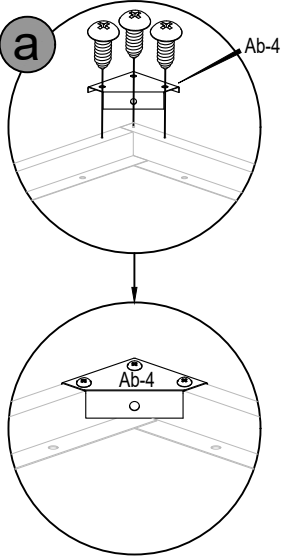

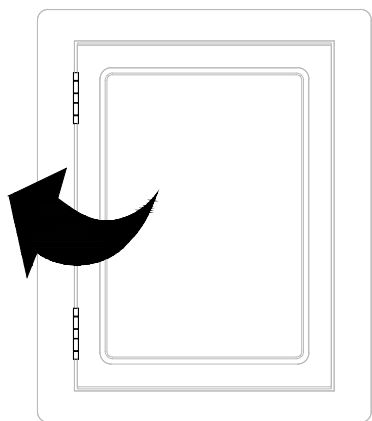
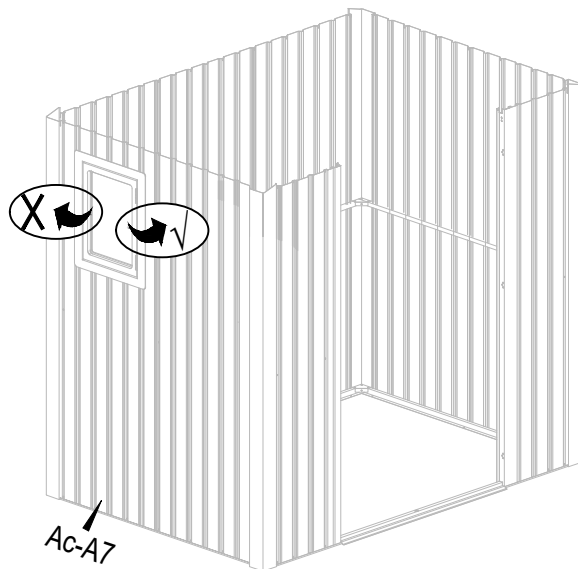
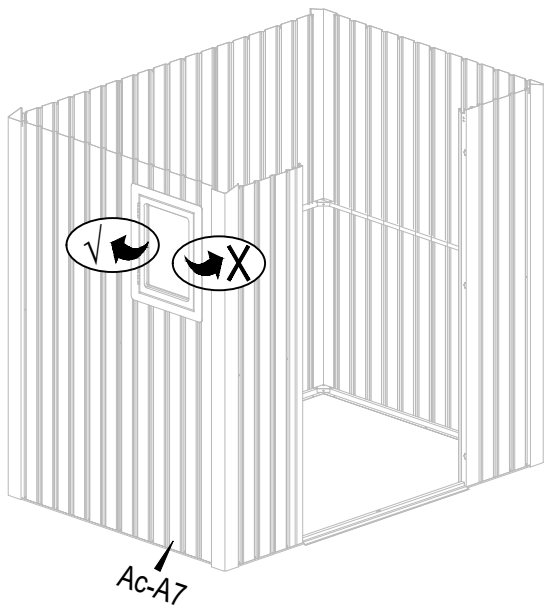
2	 Ab-4 x4	 Anj-A41 x12	
---	--	--	--



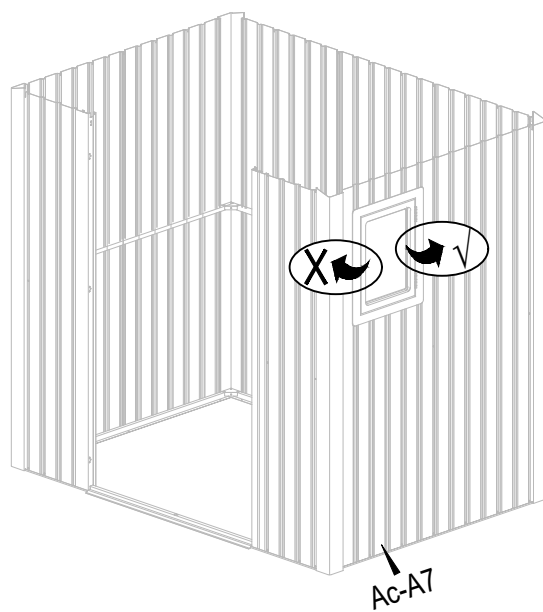
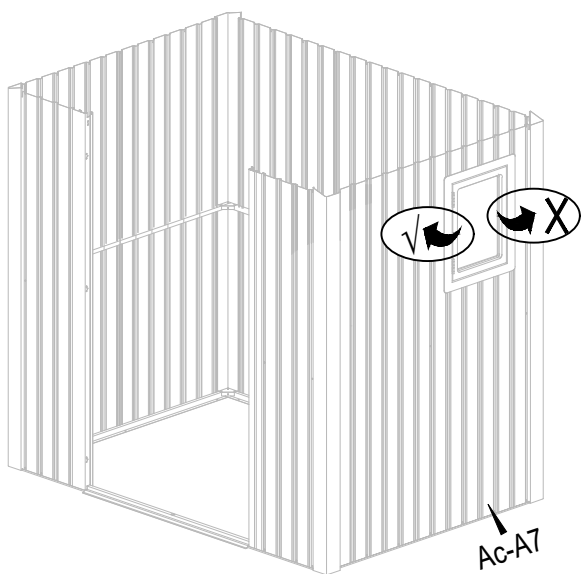
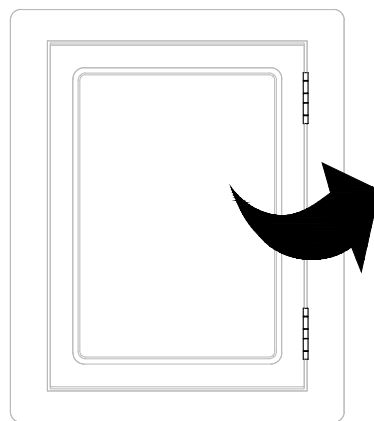

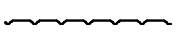



Or

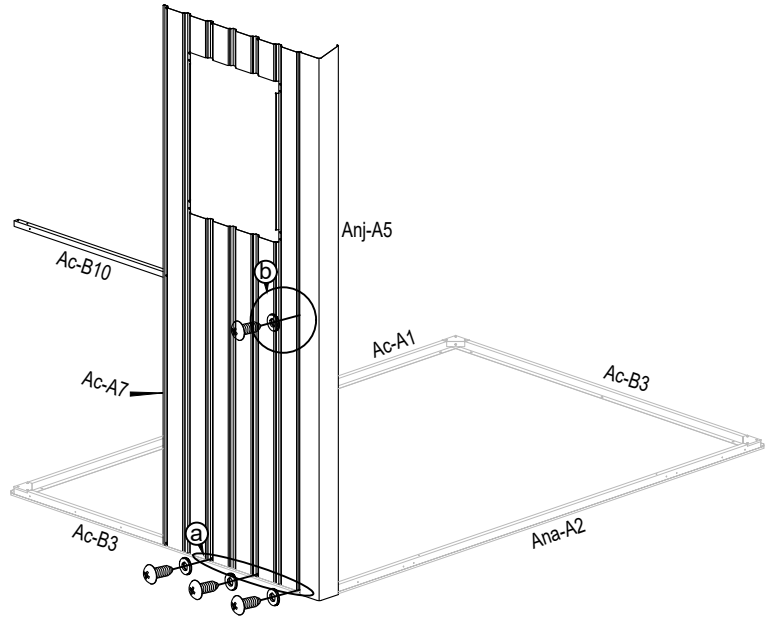
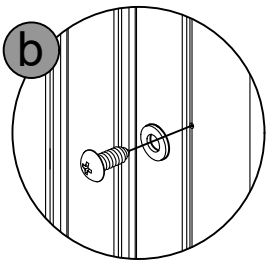
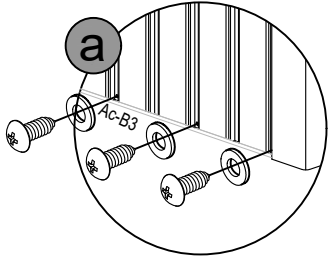
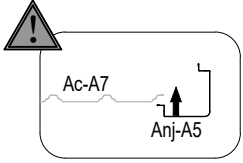

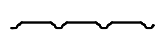
3	 Ac-A7 x1	 Anj-A5 x1	 Ac-B10 x1	 Anj-A41 x4	 Anj-A40 x4	
---	--	---	---	---	--	--



4	 Ac-A8 x1	 Ac-A11 x1	 Anj-A41 x3	 Anj-A40 x3	
---	---	--	---	--	--

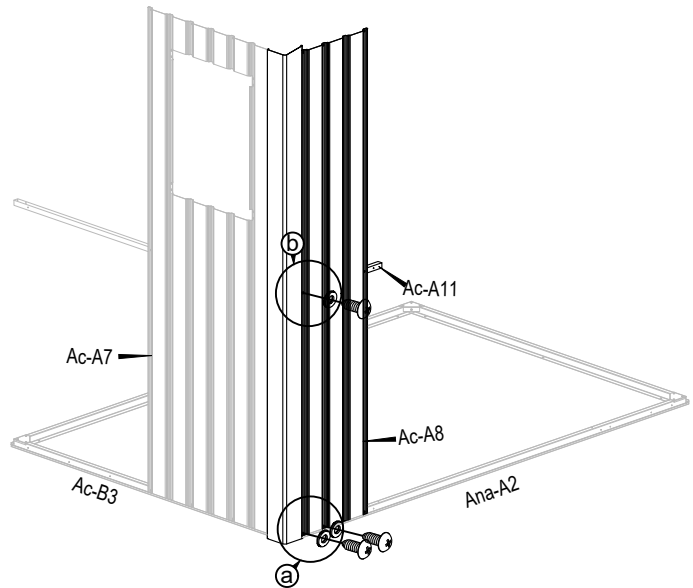
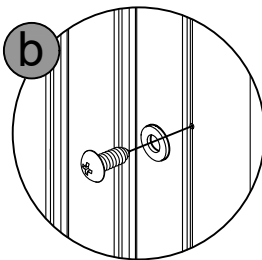
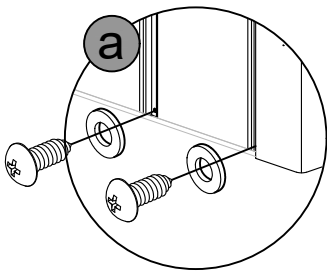

5

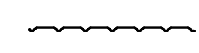

Ac-A6 x1



Anj-A5a x1



Anj-A41 x6



Anj-A40 x6

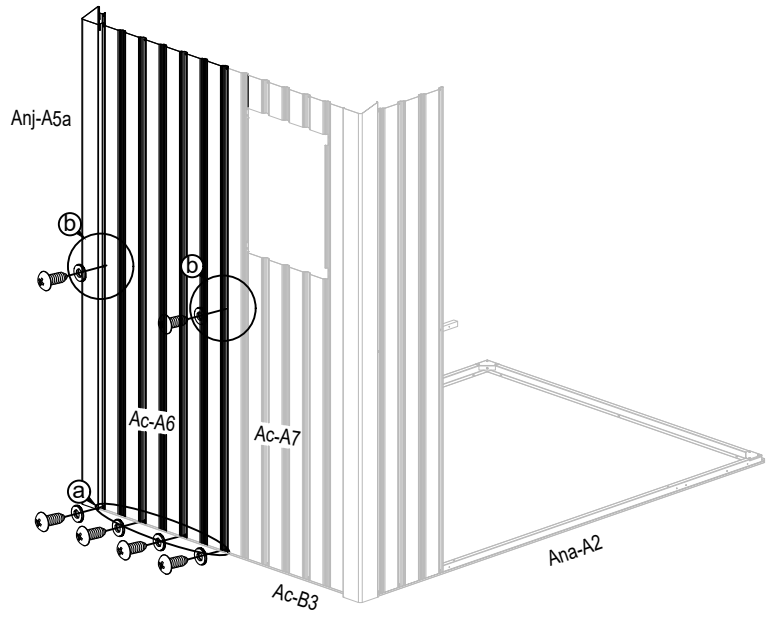
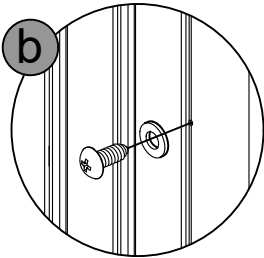
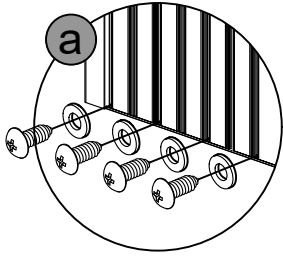

6

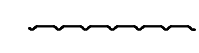

Ac-A6 x1



Ac-A9 x1



Anj-A41 x4



Anj-A40 x4

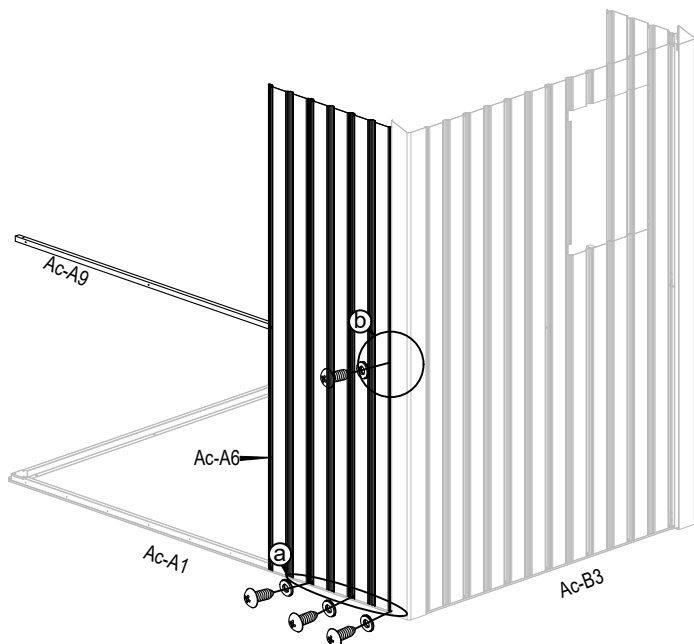
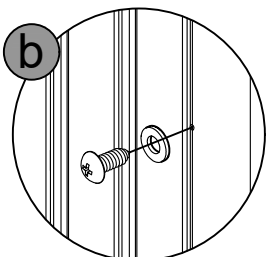
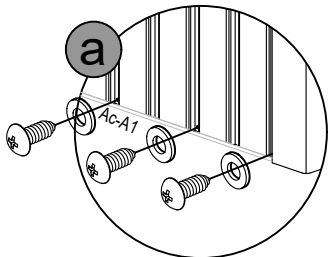

7



Ac-A6 x1



Anj-A41 x4



Anj-A40 x4

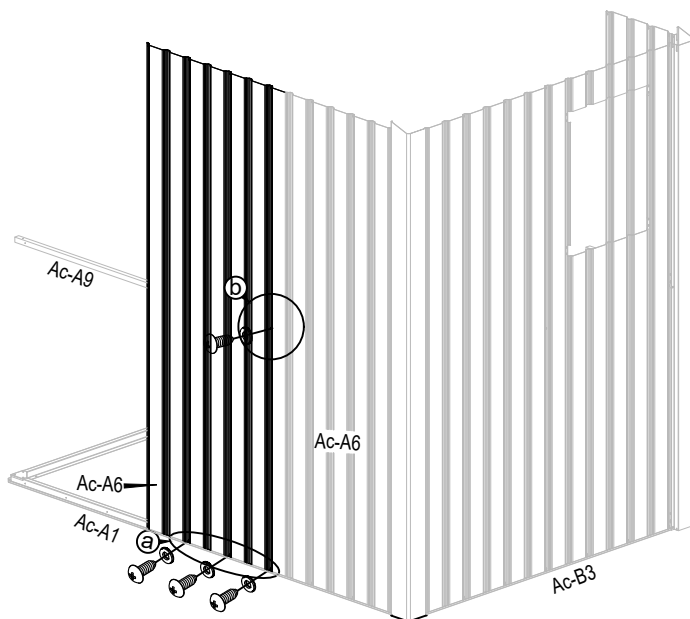
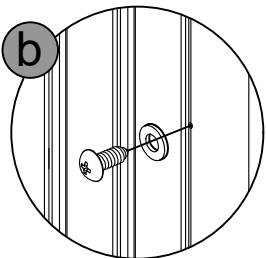
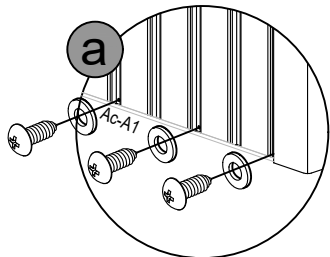

8



Ac-A6 x1



Anj-A5 x1



Anj-A41 x6



Anj-A40 x6

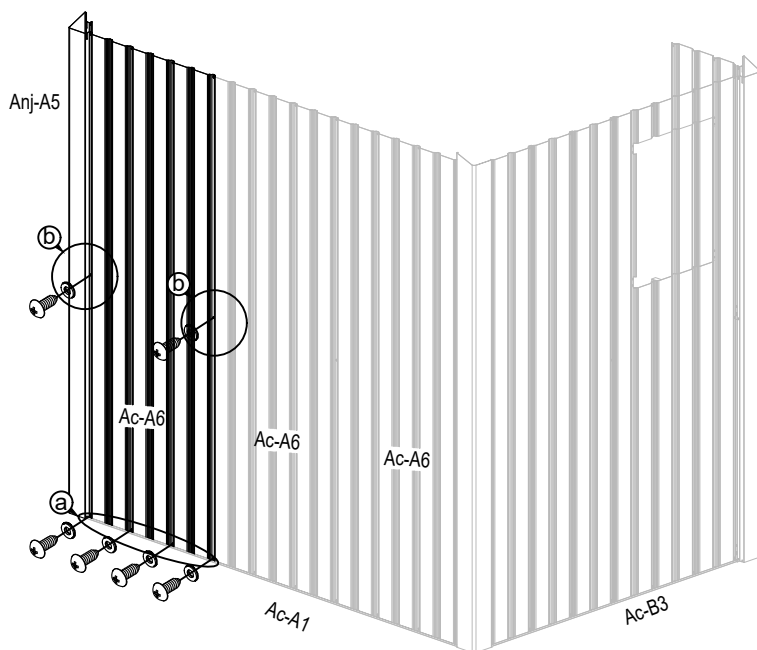
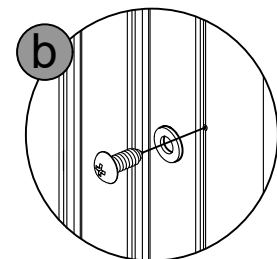
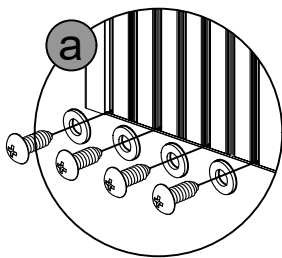

5



9

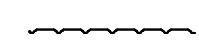

Ac-A6 x1



Ac-B10 x1



Anj-A41 x4



Anj-A40 x4

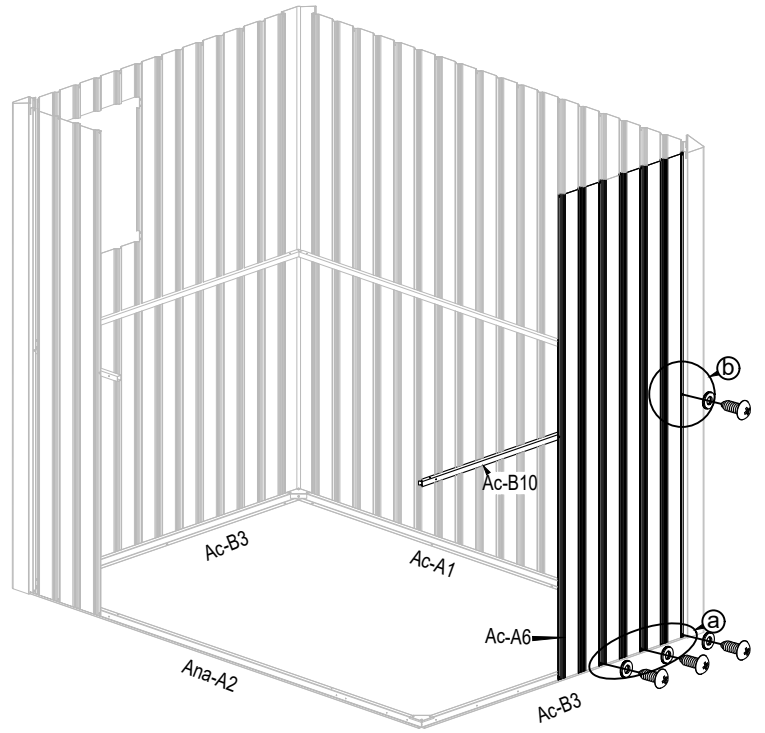
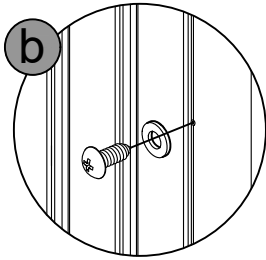
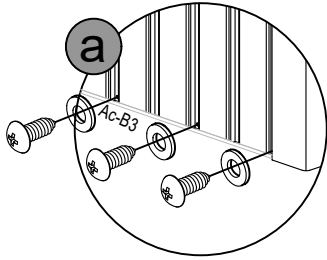

10

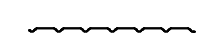

Ac-A6 x1



Anj-A5a x1



Anj-A41 x6



Anj-A40 x6

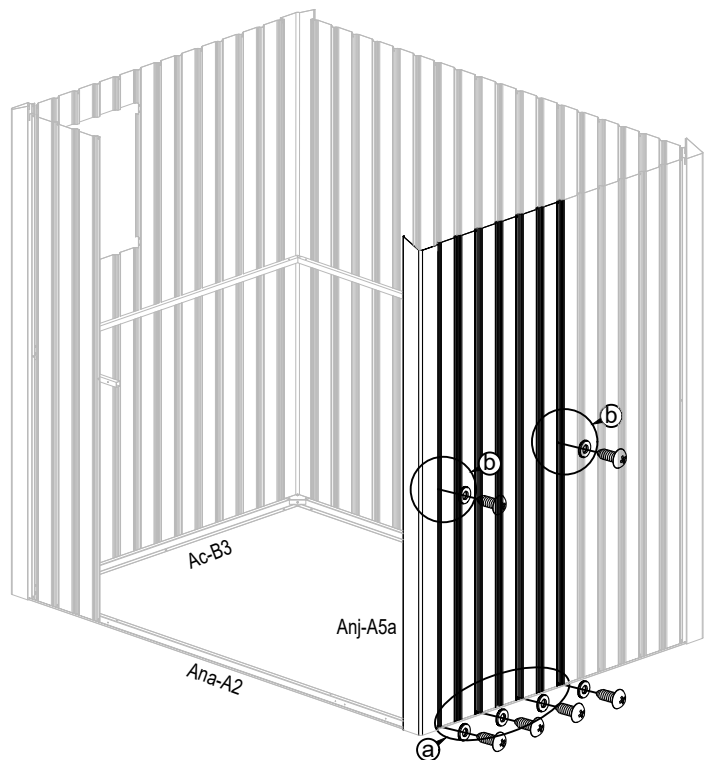
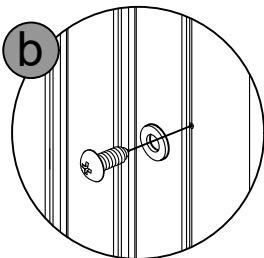
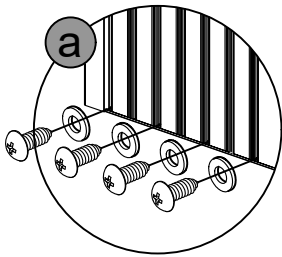

11

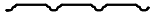

Ac-A8 x1



Ac-A11 x1



Anj-A41 x3



Anj-A40 x3

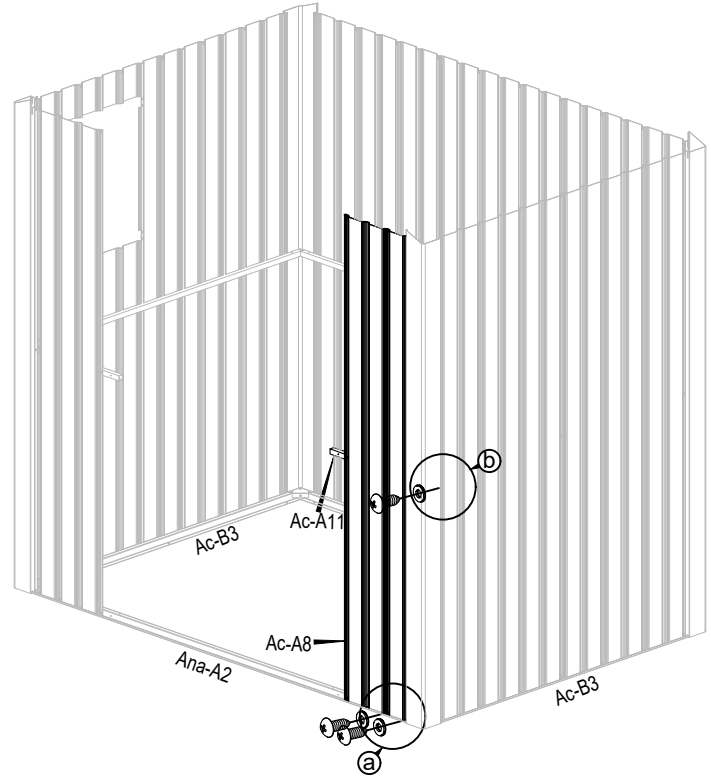
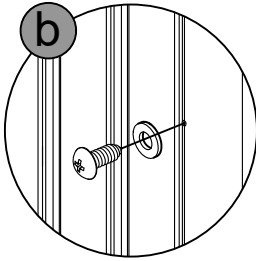
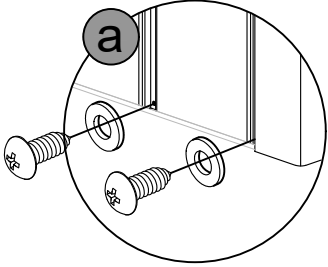

12

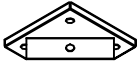

Ab-4 x4



Anj-A41 x12

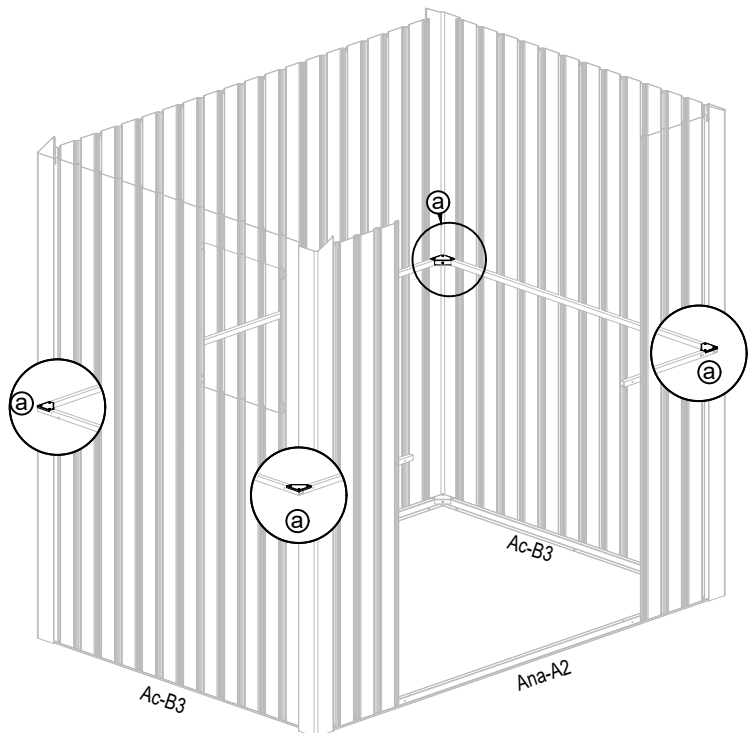
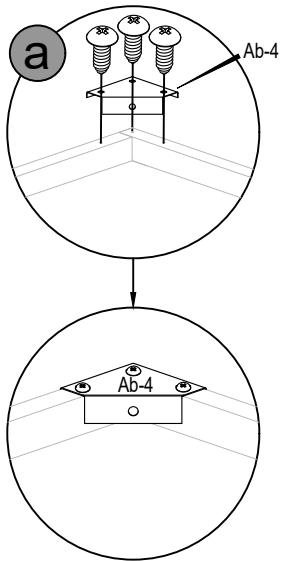

13

Anj-A13 x1



Anj-A14 x1



Anj-A41 x11



Anj-A40 x11

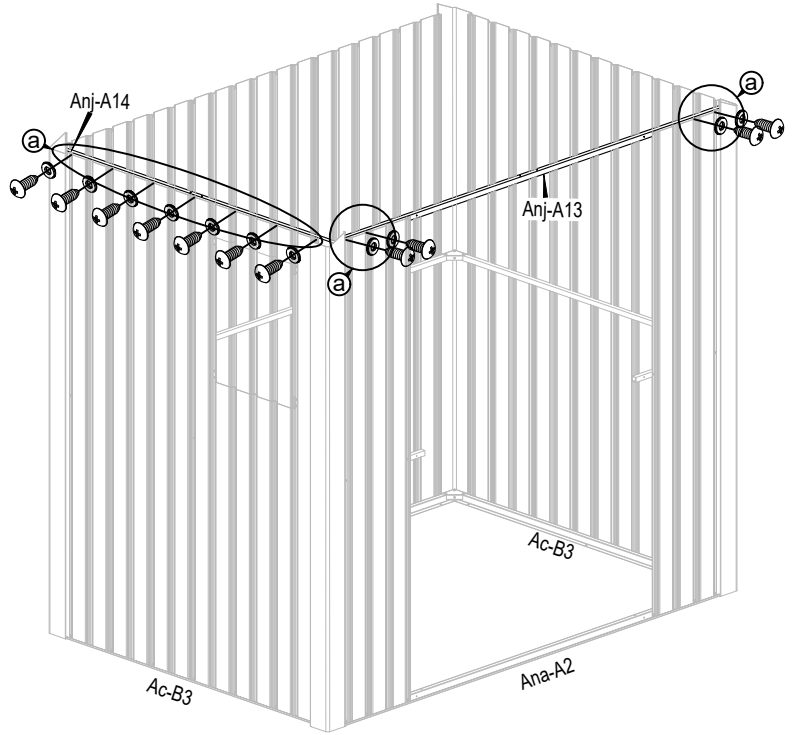
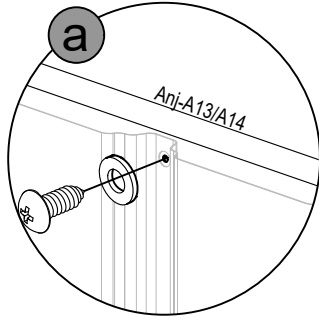

14

Anj-A12 x1



Anj-A14 x1



Anj-A41 x17



Anj-A40 x17

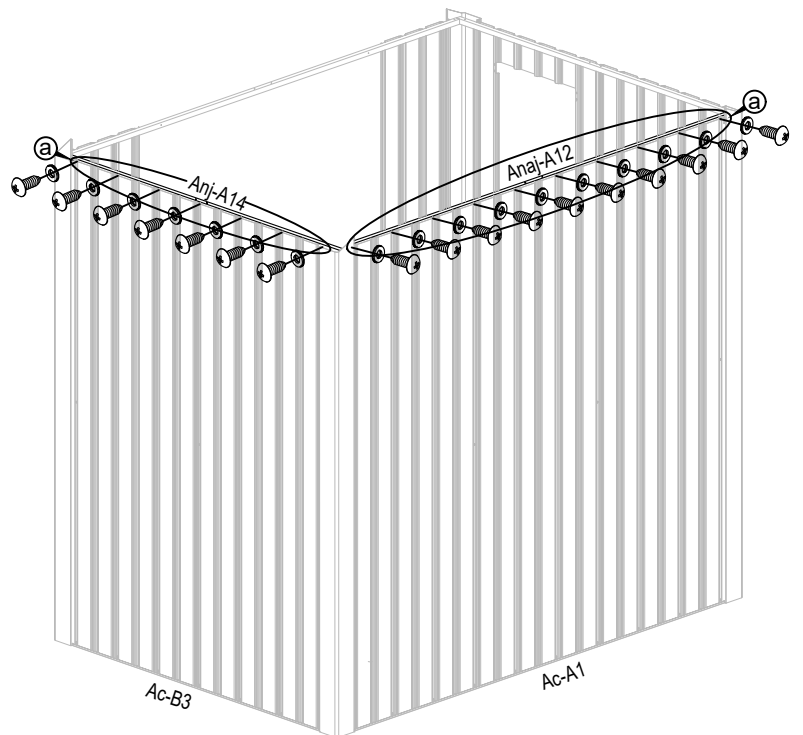
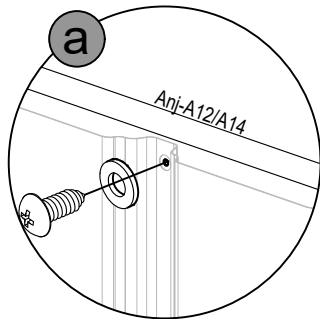

15

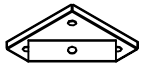

Ab-4 x4



Anj-A41 x12

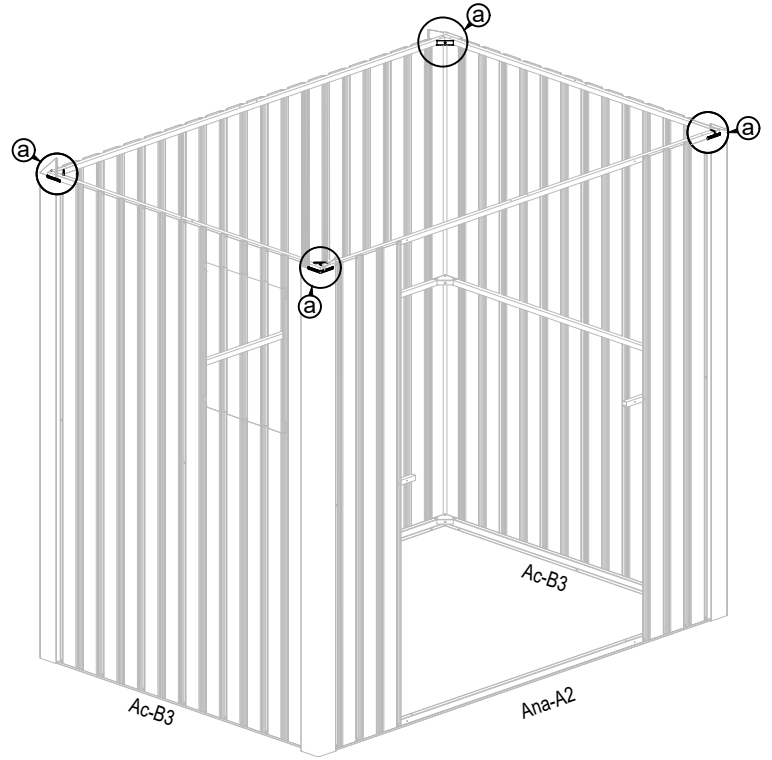
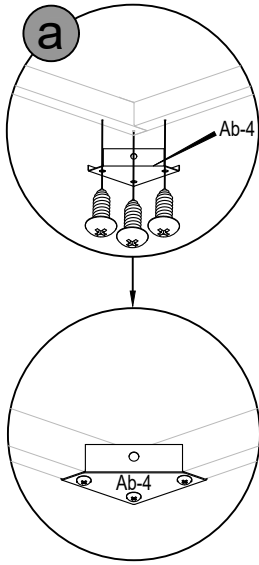

16



Ana-A4 x1



Anj-A41 x4

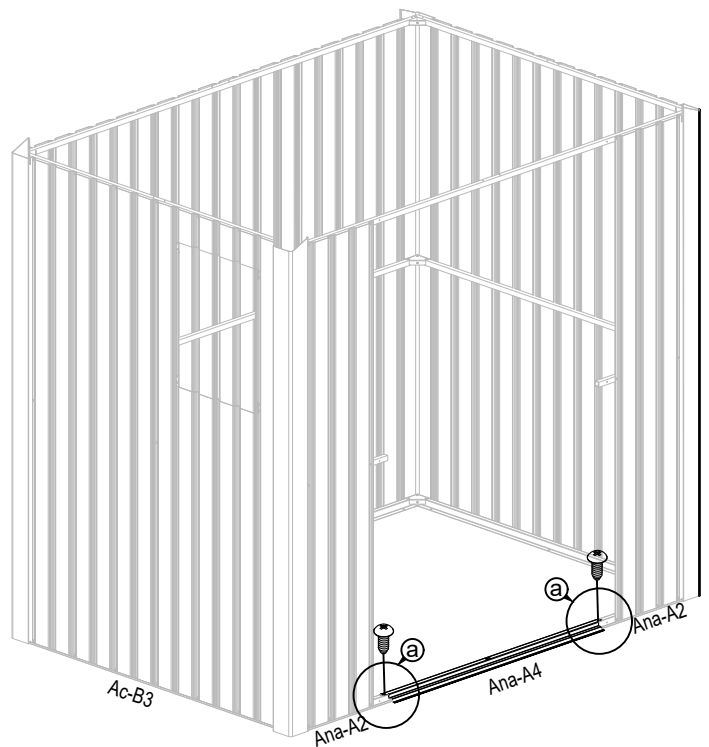
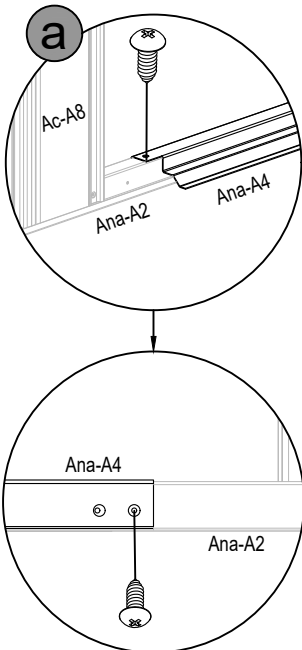
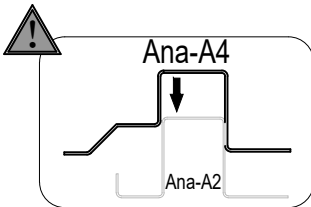

17

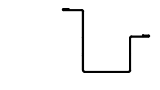

Ana-A15 x1

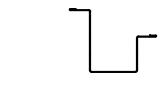

Ana-A15a x1



Anj-A41 x6

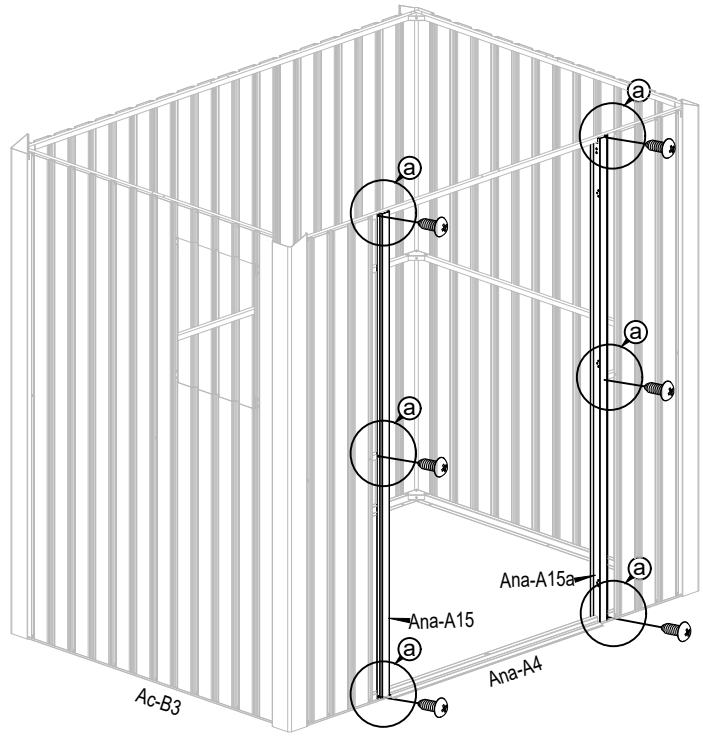
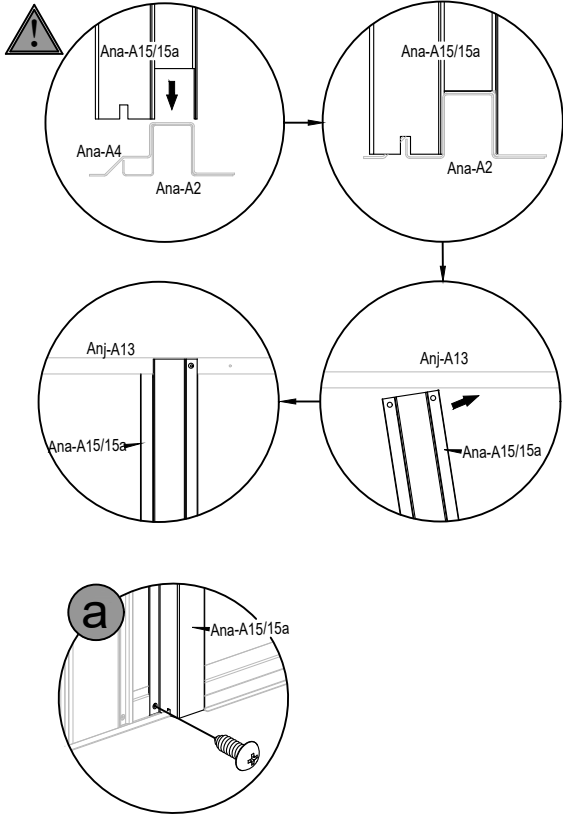

18

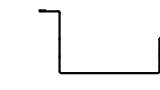

Ana-A16 x1

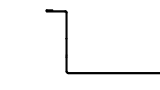

Ana-A16a x1



Anj-A41 x10



Anj-A40 x6

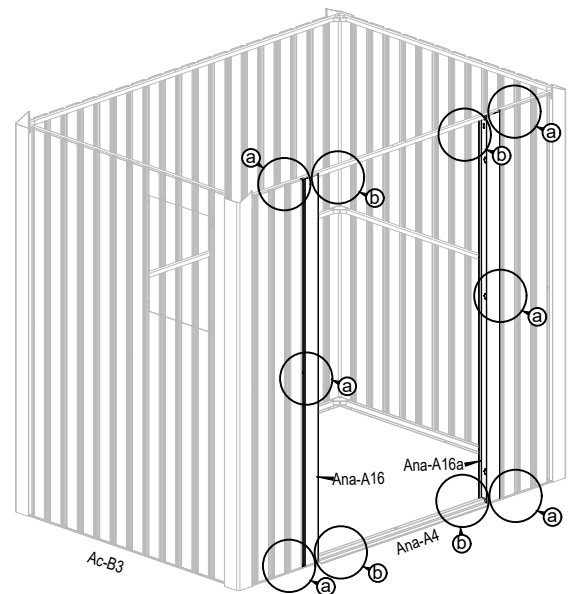
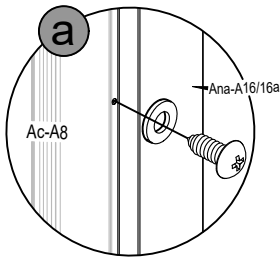
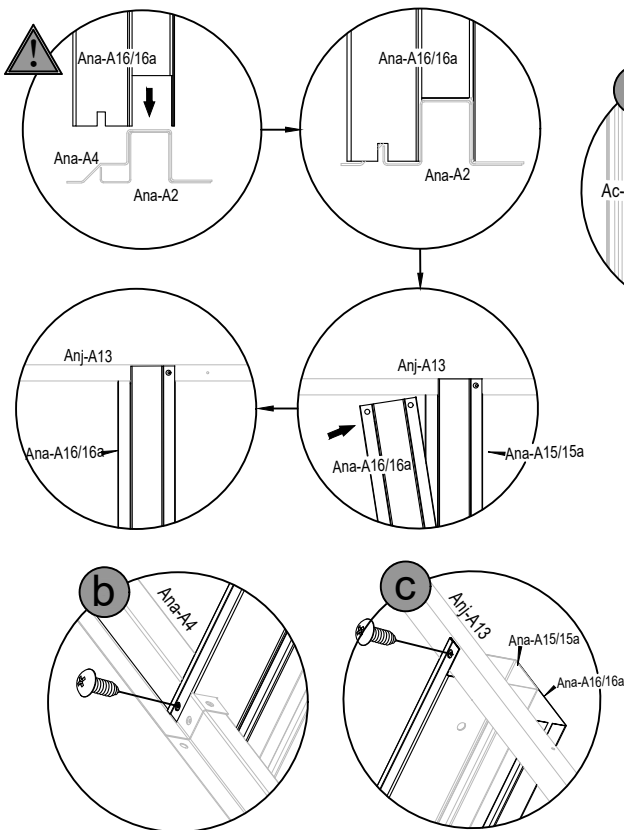

19



Ana-A17 x1



Anj-A44 x4

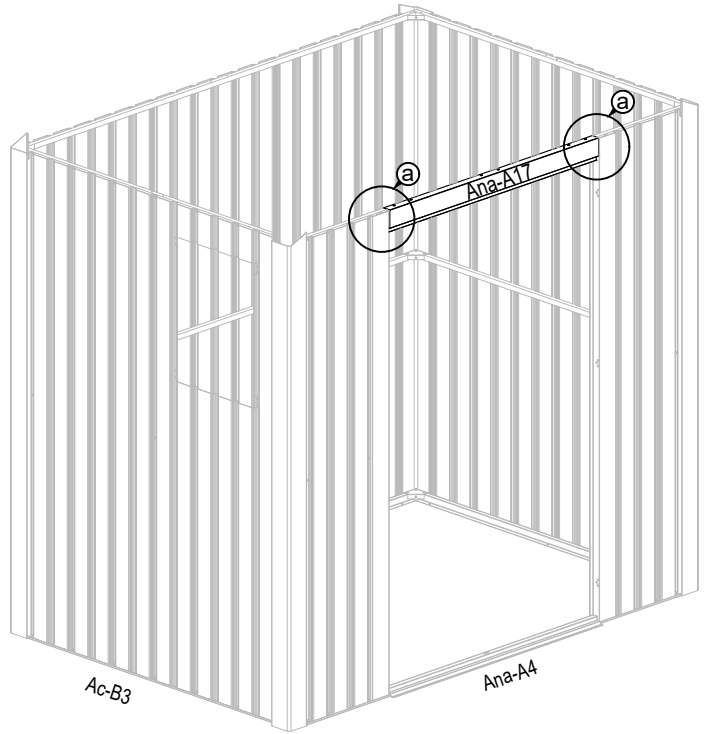
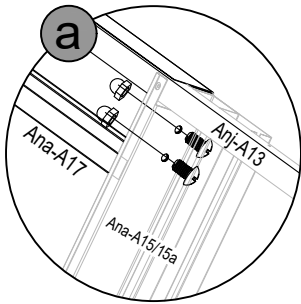
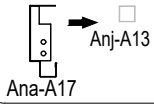

20



Anj-A18 x2

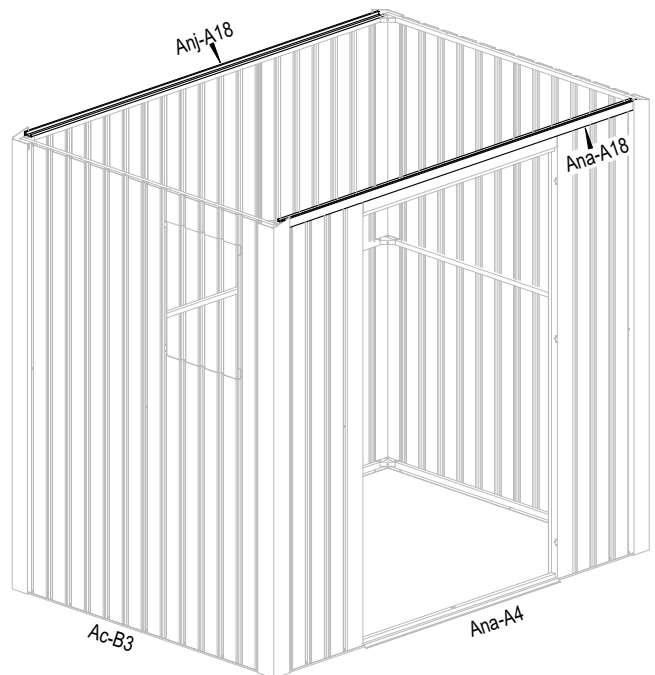
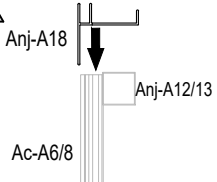

21

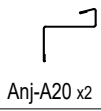

Anj-A20 x2



Anj-A41 x12

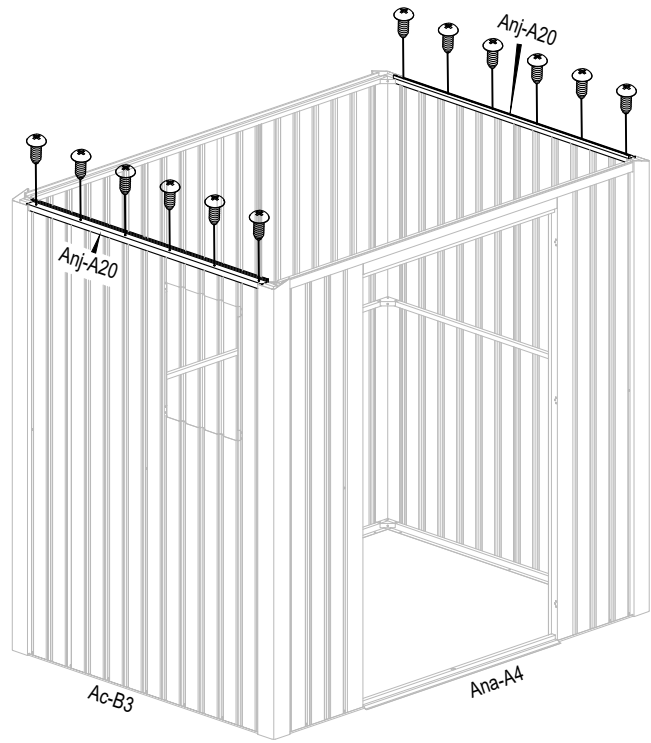
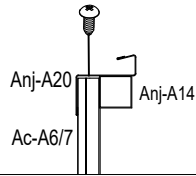
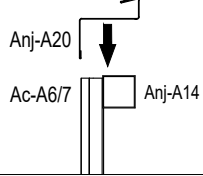

22



Anj-A22 x2



Anj-A22a x4



Anj-A41 x16

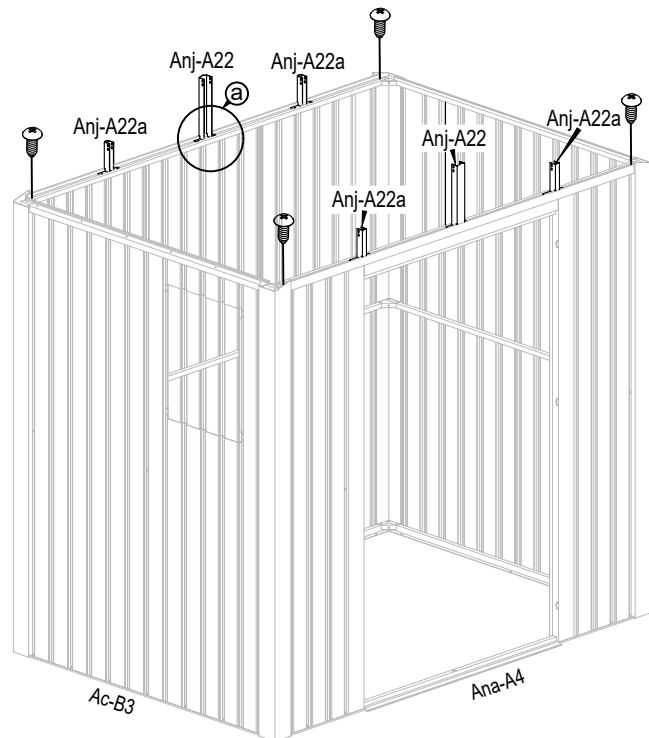
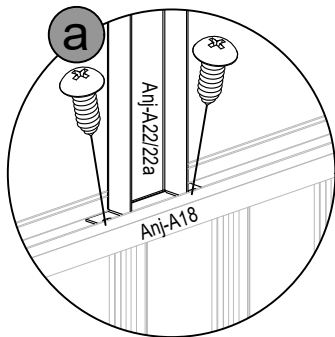

23



Anj-A23 x1



Anj-A23a x2



Anj-A41 x24

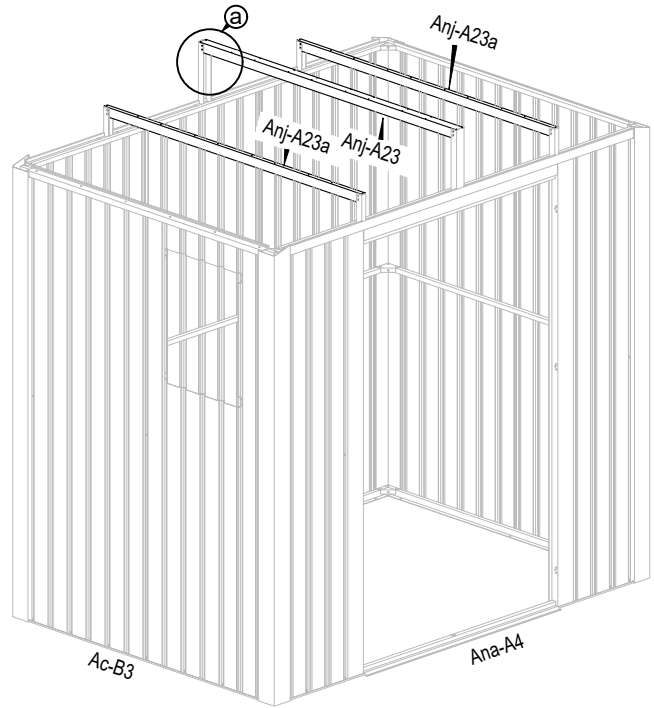
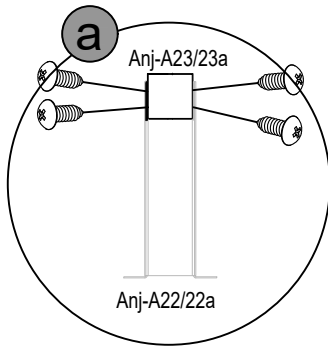

24

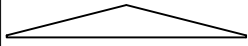

Anj-A21 x2

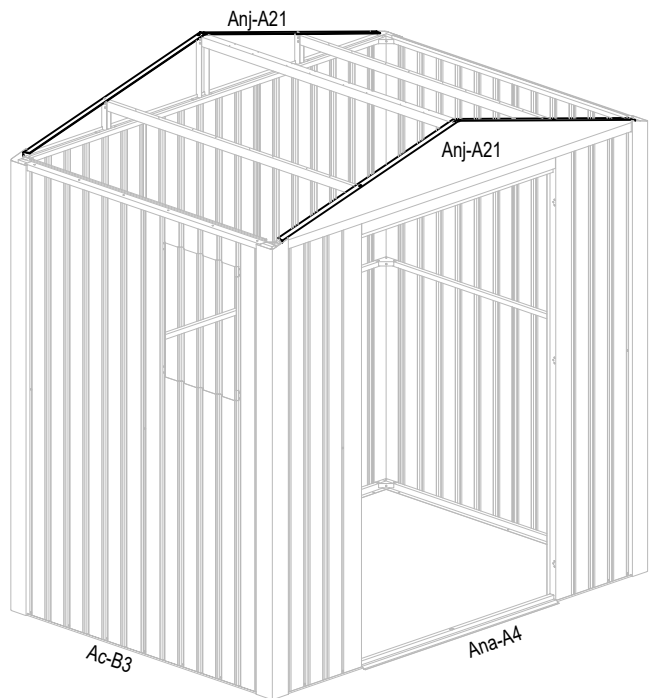
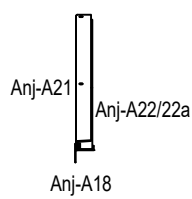
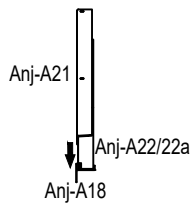
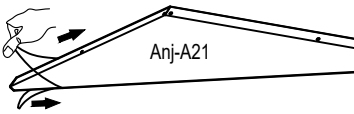

25

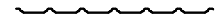

Anj-A25 x1

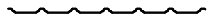

Anj-A25a x1



Anj-A41 x22



Anj-A40 x22

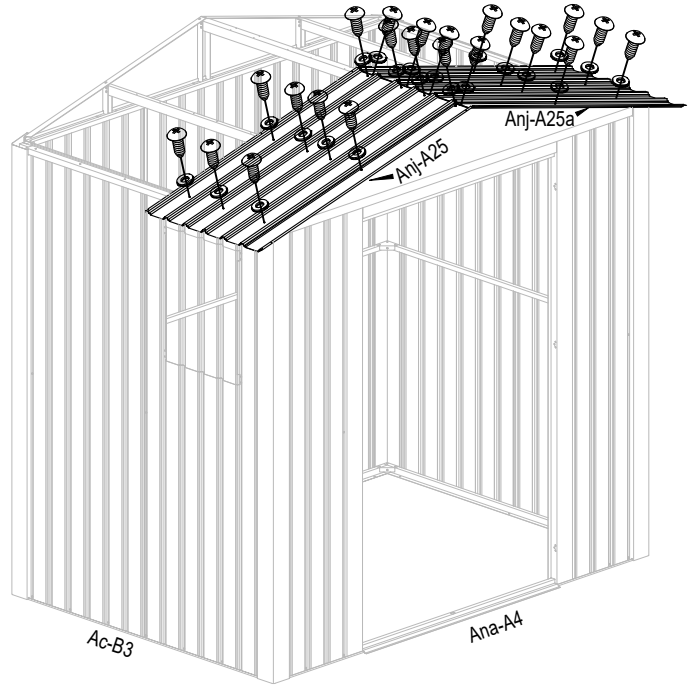
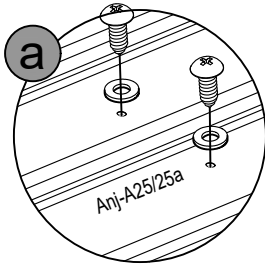

26

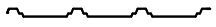

Anj-A24 x2



Anj-A41 x14



Anj-A40 x14

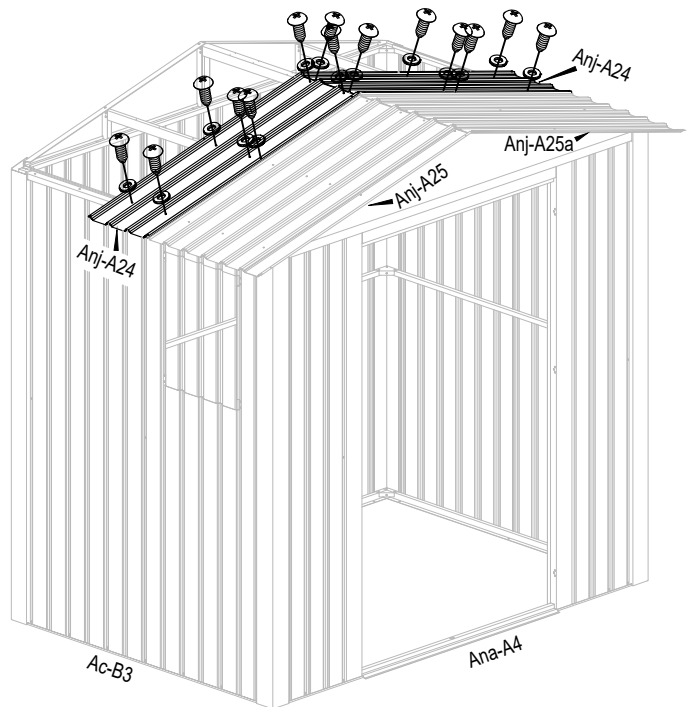
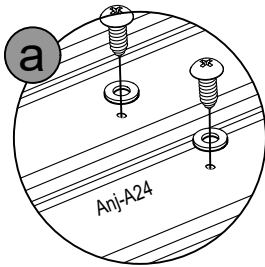
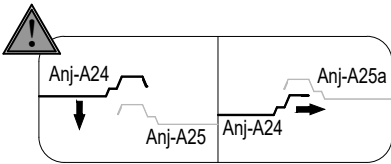

27



Anj-A25 x1

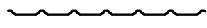

Anj-A25a x1



Anj-A41 x24



Anj-A40 x24

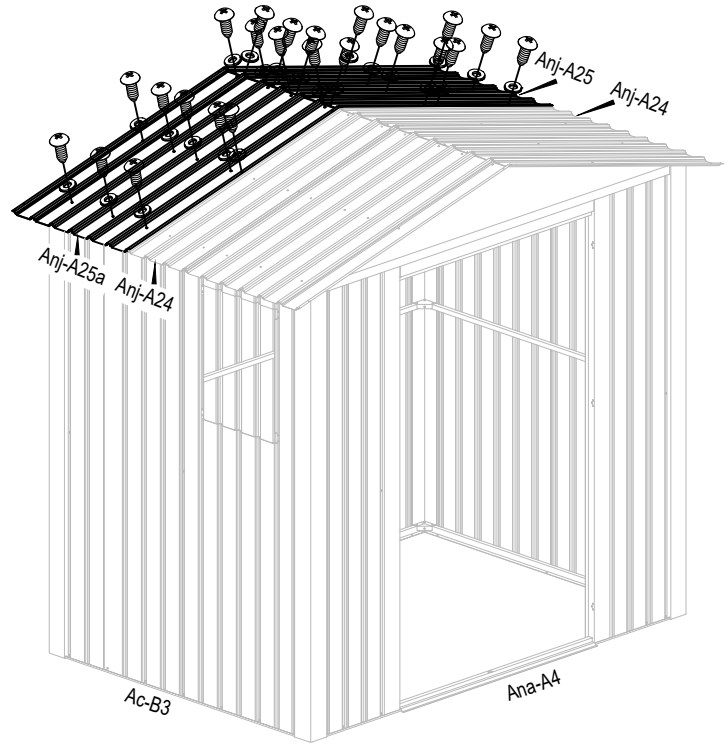
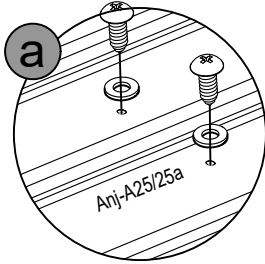
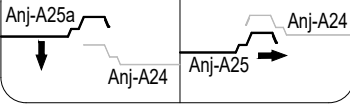

28

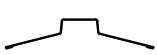

Anj-A28 x1



Anj-A46 x4



Anj-A40 x4

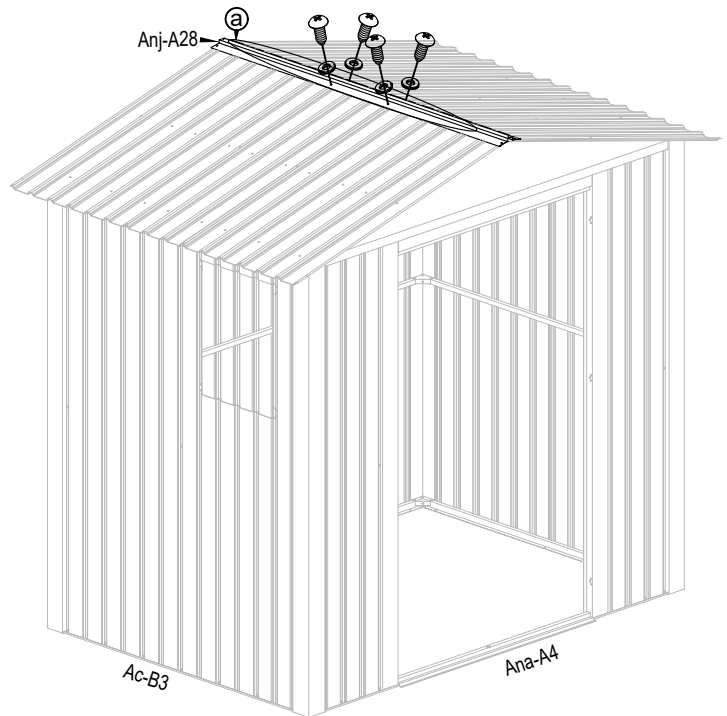
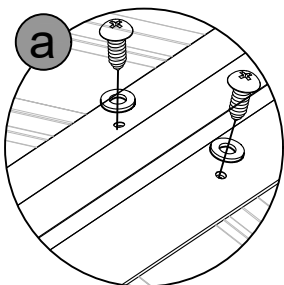

29

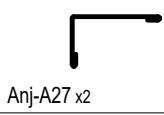

Anj-A27 x2

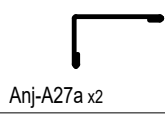

Anj-A27a x2



Anj-A41 x4



Anj-A40 x4

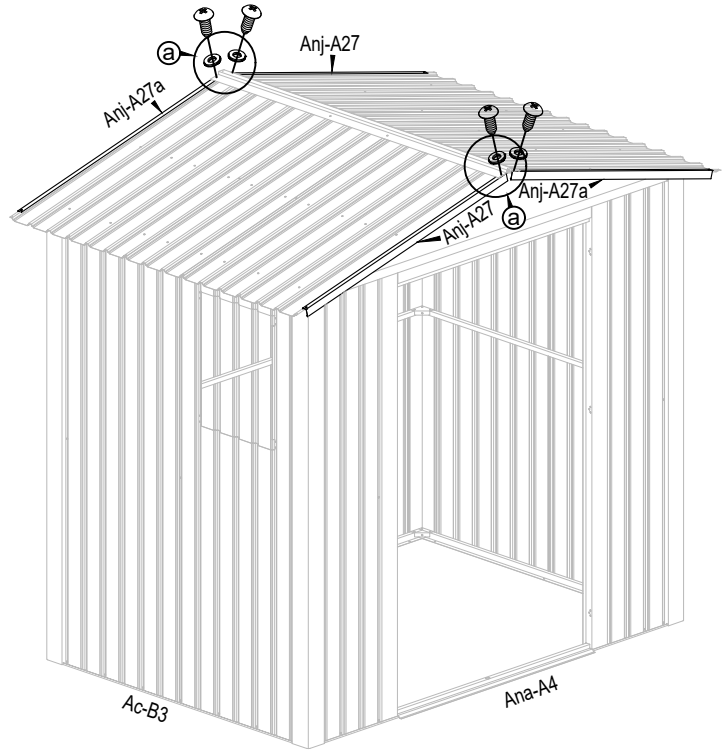
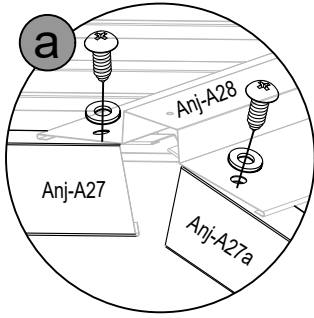

30



T-P4 x2



Anj-A41 x2

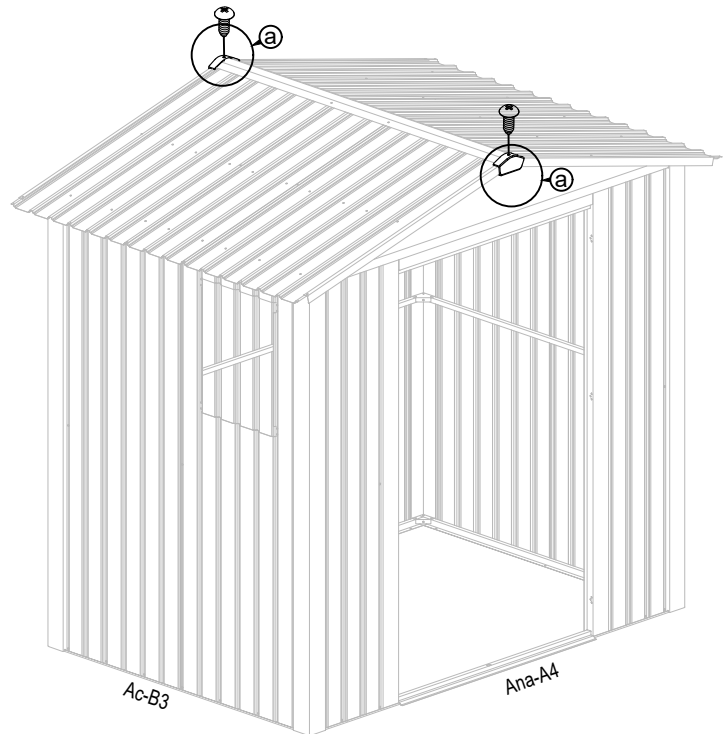
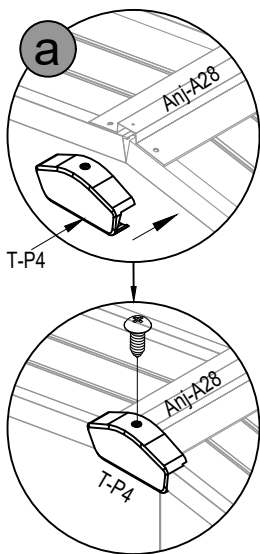

31



Anj-A26 x2



Anj-A41 x8



Anj-A40 x8

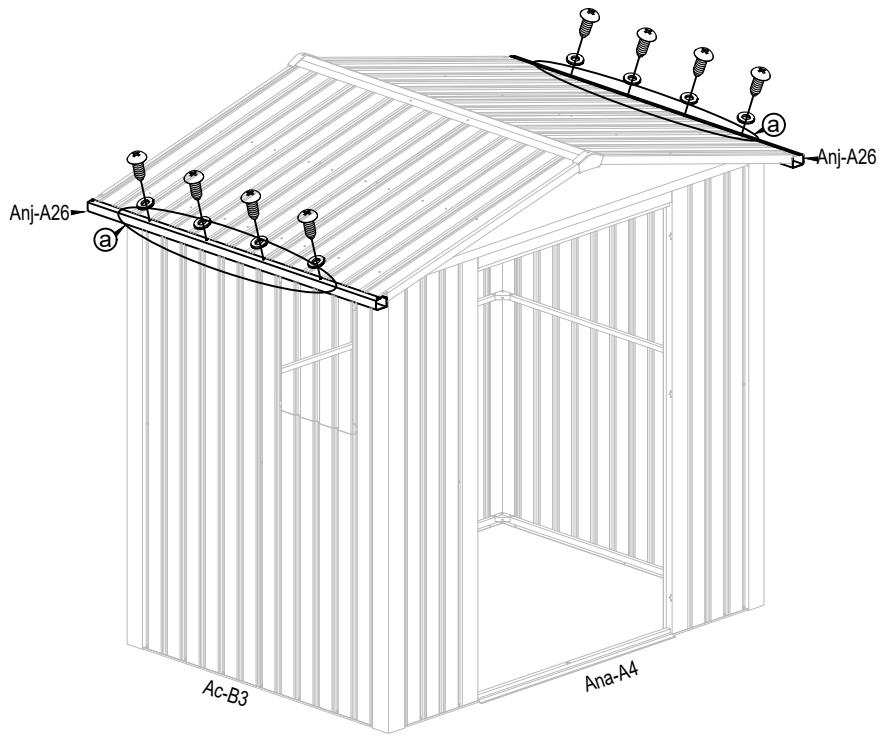
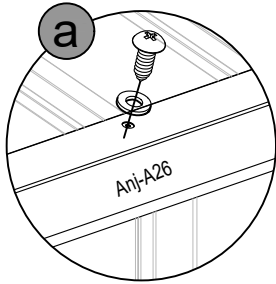
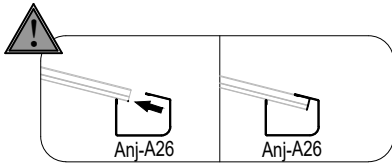

32



Ac-P1 x2



Ac-P2 x2



Anj-A41 x8

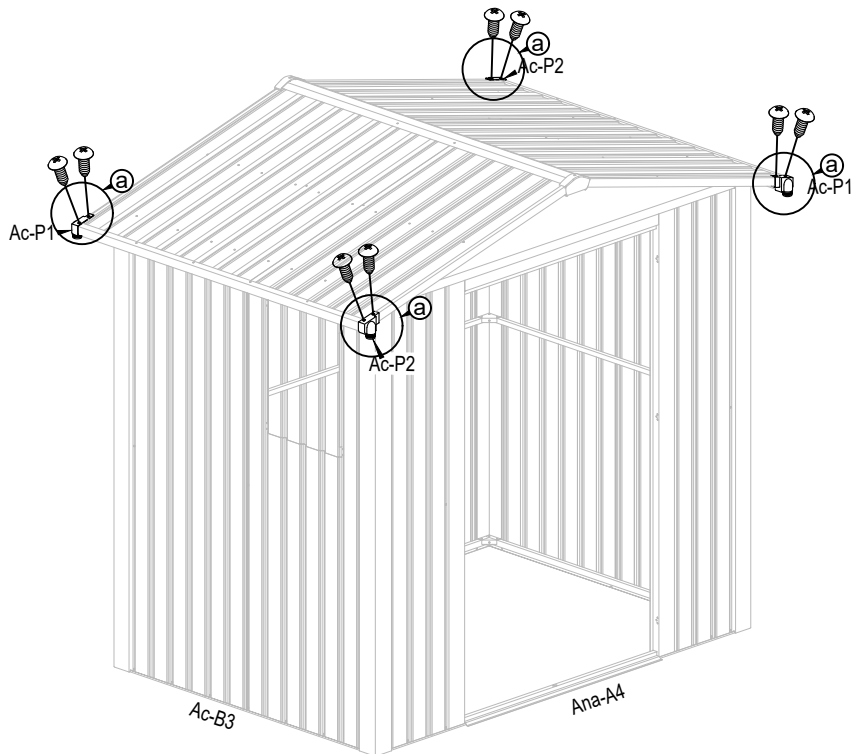
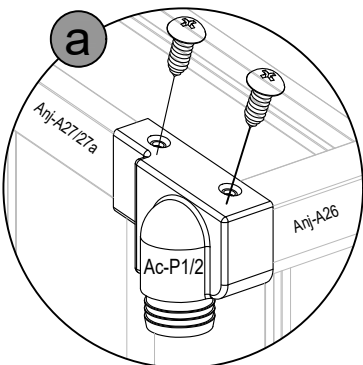
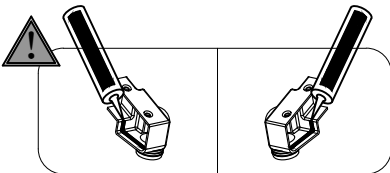

33



Ab-50 x6



Anj-A43 x18

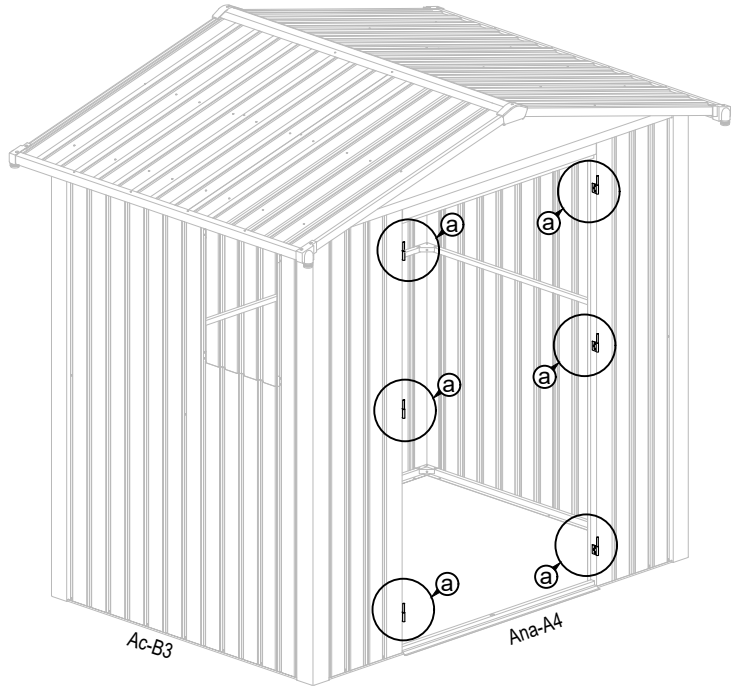
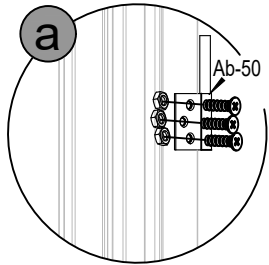

34

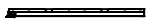

Ac-A29 x1



Ac-A29a x1



Ana-54 x1



Ana-55 x1



Ana-56 x1



Ana-57 x1



Ana-58 x3

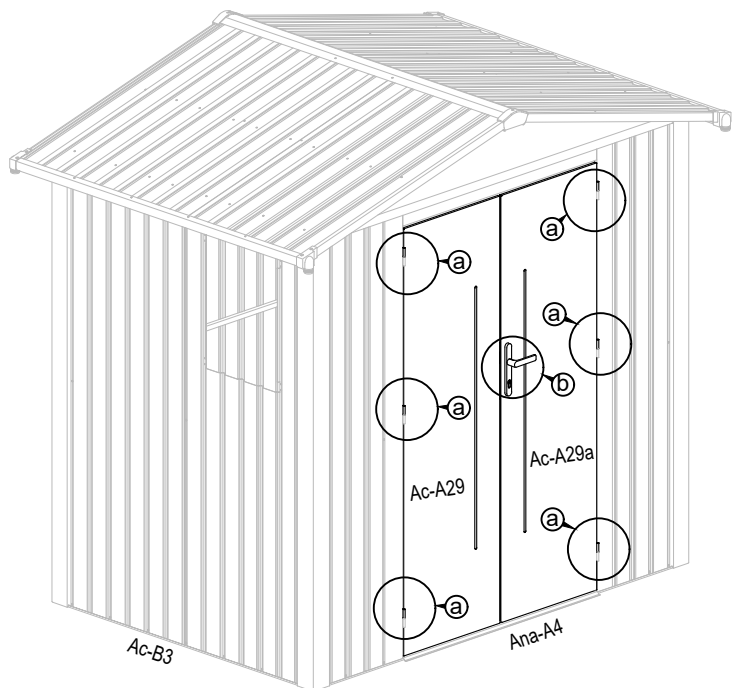
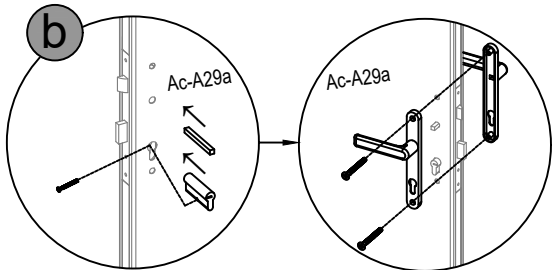
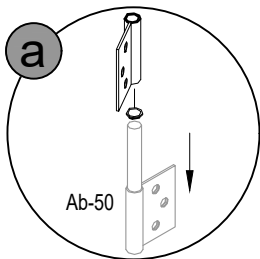

35



Ana-P6 x1



Anj-A41 x4

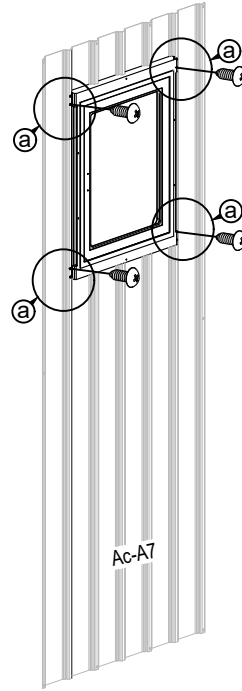
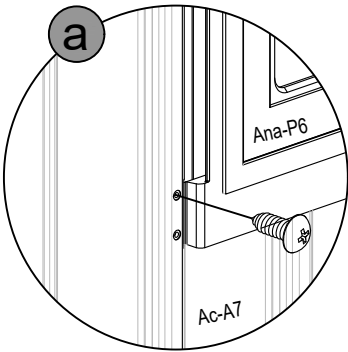
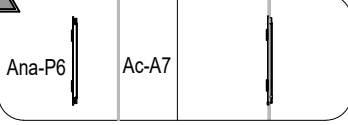

36



Ana-P7 x1



Anj-A41 x10

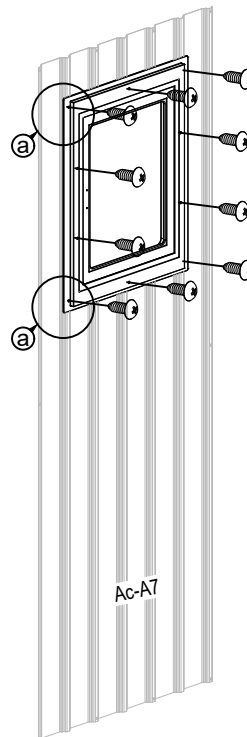
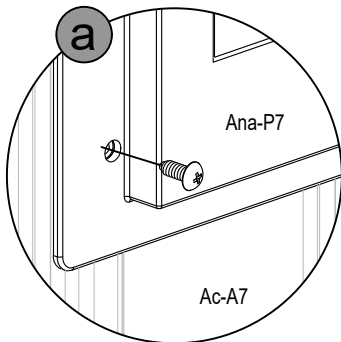
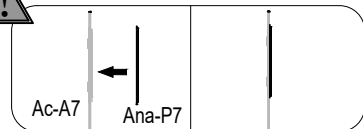

37



Ana-P8 x1



Ana-A42 x2

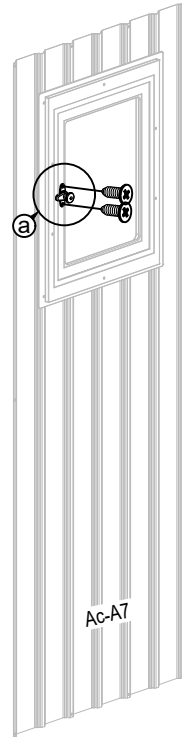
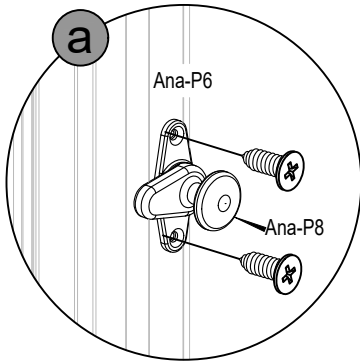

38



Anj-A37 x4M

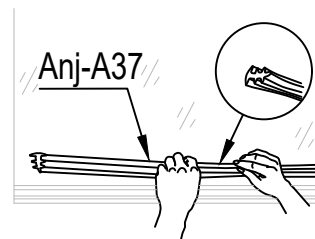
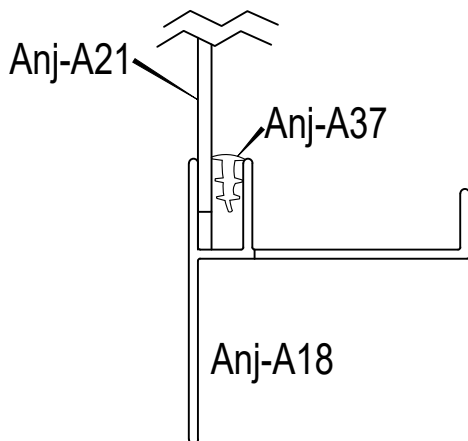

39

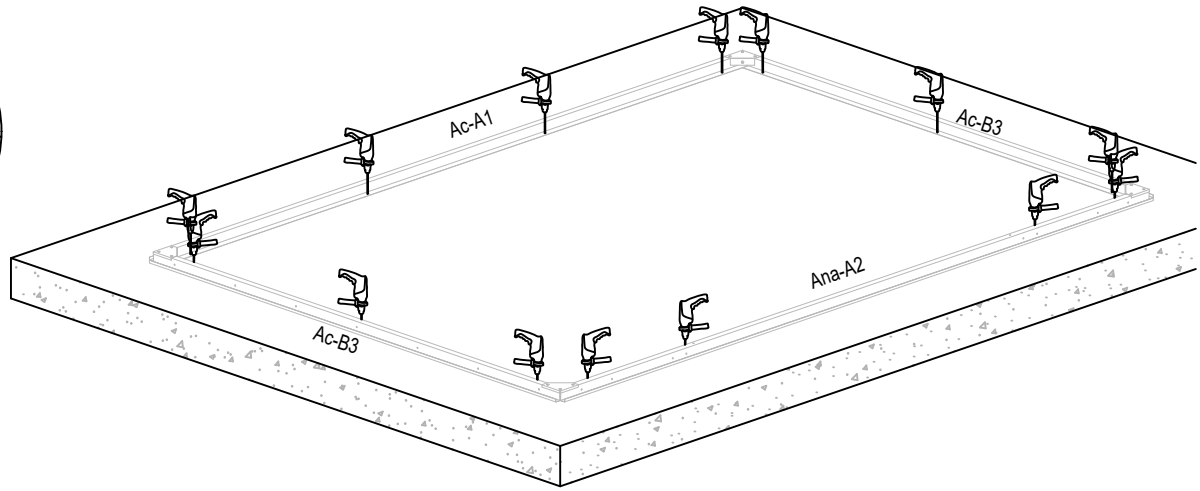
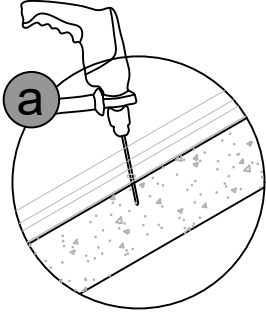
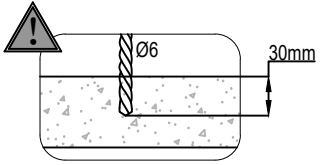
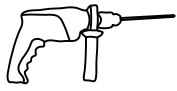

40



Anj-A45 x14

